

DRAWMER



S3

Three-Band Stereo Vacuum Tube Compressor

OPERATOR'S MANUAL

CONTENTS

Warranty	2
Safety Consideration	2
<i>Chapter 1 - Introduction</i>	
Introduction	3
Installation	4
Audio Connections	5
Power Connection	5
<i>Chapter 2 - Control Description</i>	
Control Description	6
Quick Setup Procedure	9
<i>Chapter 3 - General Information</i>	
If a fault develops	10
Contacting Drawmer	10
Specification	10
Block Diagram	11

COPYRIGHT

This manual is copyrighted © 2006 by Drawmer Electronics Ltd. With all rights reserved. Under copyright laws, no part of this publication may be reproduced, transmitted, stored in a retrieval system or translated into any language in any form by any means, mechanical, optical, electronic, recording, or otherwise, without the written permission of Drawmer Electronics Ltd.

ONE YEAR LIMITED WARRANTY

Drawmer Electronics Ltd., warrants the Drawmer S3 Three-Band Stereo Vacuum Tube Compressor to conform substantially to the specifications of this manual for a period of one year from the original date of purchase when used in accordance with the specifications detailed in this manual. In the case of a valid warranty claim, your sole and exclusive remedy and Drawmer's entire liability under any theory of liability will be to, at Drawmer's discretion, repair or replace the product without charge, or, if not possible, to refund the purchase price to you. This warranty is not transferable. It applies only to the original purchaser of the product.

For warranty service please call your local Drawmer dealer. Alternatively call Drawmer Electronics Ltd. at +44 (0)1709 527574. Then ship the defective product, with transportation and insurance charges prepaid, to Drawmer Electronics Ltd., Coleman Street, Parkgate, Rotherham, S62 6EL UK. Write the RA number in large letters in a prominent position on the shipping box. Enclose your name, address, telephone number, copy of the original sales invoice and a detailed description of the problem. Drawmer will not accept responsibility for loss or damage during transit.

This warranty is void if the product has been damaged by misuse, modification or unauthorised repair.

THIS WARRANTY IS IN LIEU OF ALL WARRANTIES, WHETHER ORAL OR WRITTEN, EXPRESSED, IMPLIED OR STATUTORY. DRAWMER MAKES NO OTHER WARRANTY EITHER EXPRESS OR IMPLIED, INCLUDING, WITHOUT LIMITATION, ANY IMPLIED WARRANTIES OF MERCHANTABILITY, FITNESS FOR A PARTICULAR PURPOSE, OR NON-INFRINGEMENT. PURCHASER'S SOLE AND EXCLUSIVE REMEDY UNDER THIS WARRANTY SHALL BE REPAIR OR REPLACEMENT AS SPECIFIED HEREIN.

IN NO EVENT WILL DRAWMER ELECTRONICS LTD. BE LIABLE FOR ANY DIRECT, INDIRECT, SPECIAL, INCIDENTAL OR CONSEQUENTIAL DAMAGES RESULTING FROM ANY DEFECT IN THE PRODUCT, INCLUDING LOST PROFITS, DAMAGE TO PROPERTY, AND, TO THE EXTENT PERMITTED BY LAW, DAMAGE FOR PERSONAL INJURY, EVEN IF DRAWMER HAS BEEN ADVISED OF THE POSSIBILITY OF SUCH DAMAGES.

Some states and specific countries do not allow the exclusion of implied warranties or limitations on how long an implied warranty may last, so the above limitations may not apply to you. This warranty gives you specific legal rights. You may have additional rights that vary from state to state, and country to country.

DRAWMER

S3

Three-Band Stereo Vacuum Tube Compressor

SAFETY CONSIDERATIONS

CAUTION - MAINS FUSE

TO REDUCE THE RISK OF FIRE
REPLACE THE MAINS FUSE ONLY WITH
A FUSE THAT **CONFORMS TO IEC127-2.**
250 VOLT WORKING, TIME DELAY TYPE
AND BODY SIZE OF 20mm x 5mm.
THE MAINS INPUT FUSE MUST BE
RATED AT 230V=T500mA and 115V=T1Amp.

CAUTION - MAINS CABLE

DO NOT ATTEMPT TO CHANGE
OR TAMPER WITH THE
SUPPLIED MAINS CABLE.

CAUTION - SERVICING

DO NOT PERFORM ANY SERVICING.
REFER ALL SERVICING TO QUALIFIED
SERVICE PERSONNEL.

WARNING

TO REDUCE THE RISK OF FIRE OR
ELECTRIC SHOCK DO NOT EXPOSE
THIS EQUIPMENT TO RAIN OR MOISTURE.



In the interests of product development, Drawmer reserve the right to modify or improve specifications of this product at any time, without prior notice.

DRAWMER

S3

THREE-BAND STEREO VACUUM TUBE COMPRESSOR



INTRODUCTION

The new S3 Three-Band Stereo Vacuum Tube Compressor incorporates the very latest in Ivor Drawmer designs and the aim from the very beginning was to create a 'no technical compromise' circuit using only the highest grade

components. The S3 forms the basis of a 'Signature Series' and offers previously unattainable control and tonality over each of the three bands - gain control at each stage provides precise spectral balancing.

The Key Features are as follows:

- Fully balanced signal path class A design
- Isolation transformers in and out
- 20 x active tube stages
- High power 'push/pull' output stage delivering up to +30dBu
- Variable band split points
- Switchable 'peak' or 'VU' metering to display transients, with +10dB or +20dB re-scaling
- 'Air' mode for high band
- 'Big' mode for low band
- Switchable mute and bypass on each band
- Individual gain reduction metering on all bands

INSTALLATION

The S3 is designed for standard 19" rack mounting and occupies 3U of rack space. Fibre or plastic washers may be used to prevent the front panel becoming marked by the mounting bolts. Always connect the mains earth to the unit.

Because the S3 contains ten valves it will generate more heat than a simple solid state unit. Avoid mounting the unit directly above power amplifiers or power supplies that radiate significant amounts of heat. In addition it is advised that you leave at least 1U of space above to allow heat to dissipate. Alternatively, a fan should be fitted somewhere near to the rear of the unit to circulate cooler air and help expel any excess heat. (see fig. 1).

It is also recommended to the S3 is mounted horizontally to allow heat to escape vertically through the vents on the lid. To mount at an angle may cause the S3 to overheat which will damage internal components (see fig. 2).

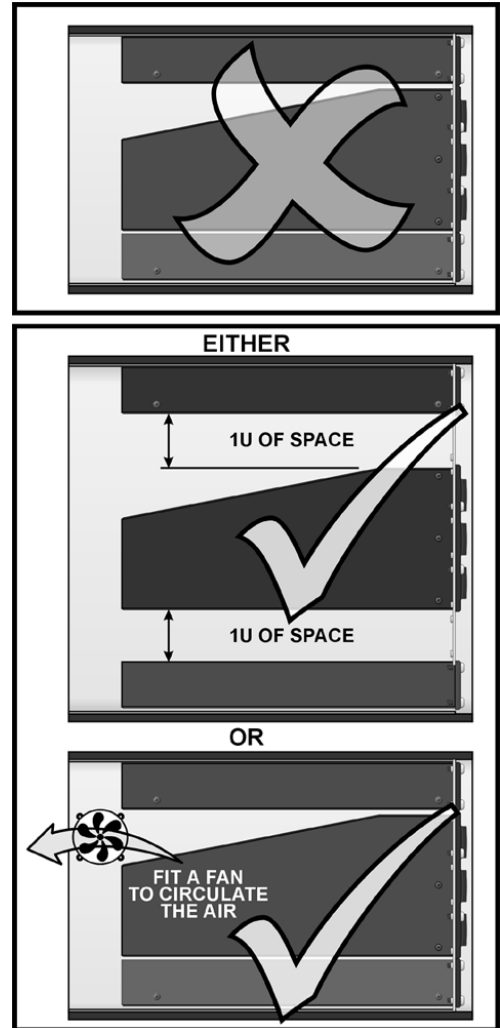

fig.1 RACK MOUNT POSITIONING

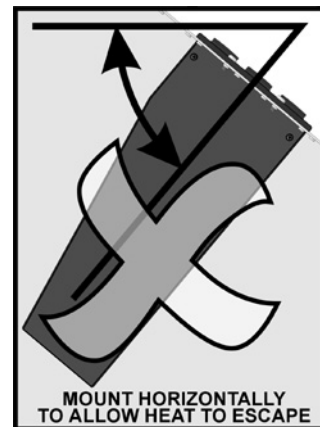

fig.2 MOUNT HORIZONTALLY

Stereo Signal Input

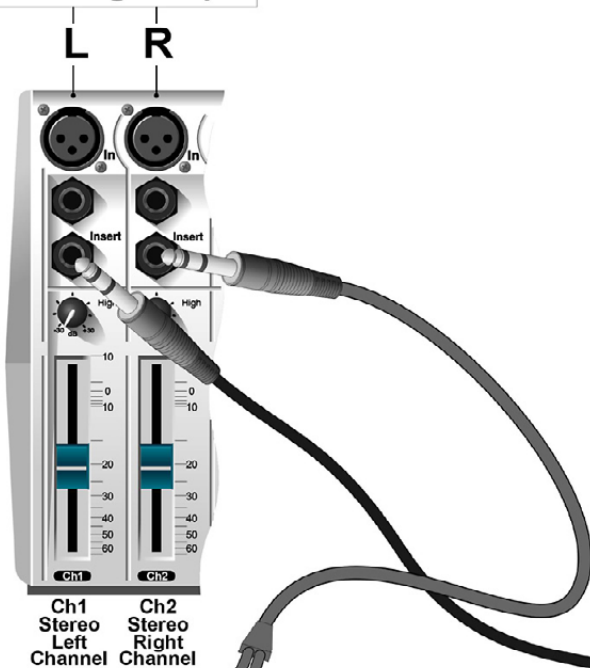
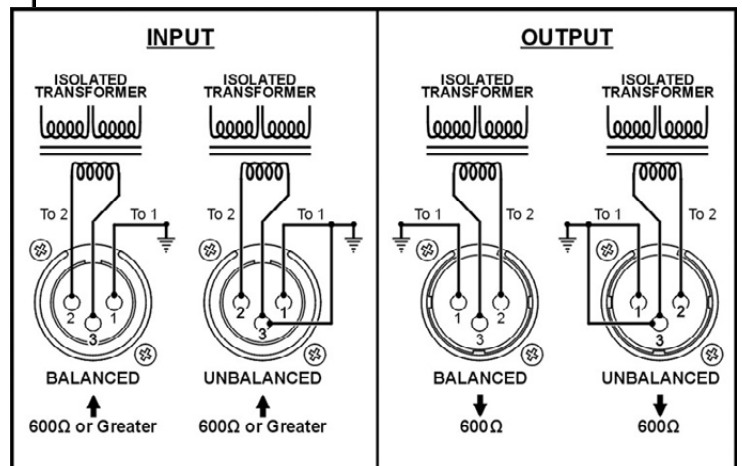
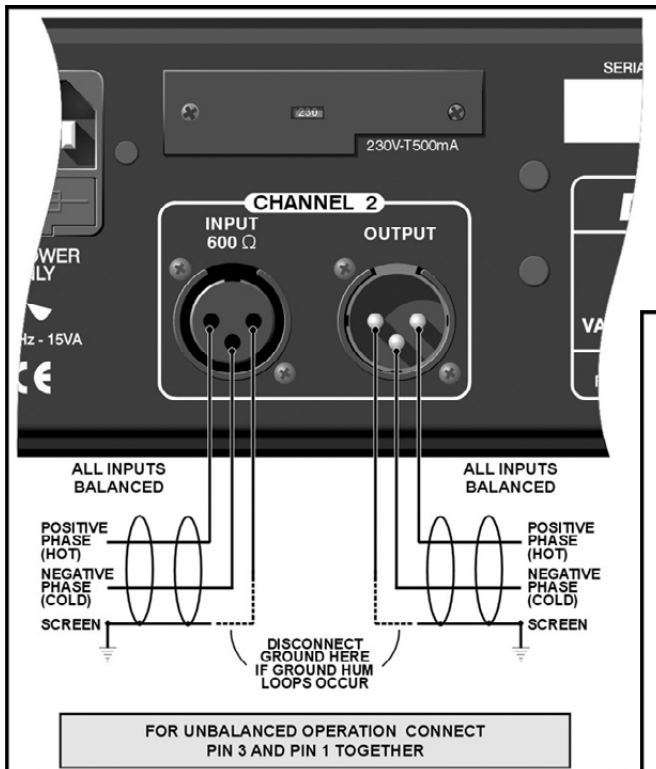

fig.2 TYPICAL S3 SETUP

AUDIO CONNECTIONS

The inputs and outputs are electronically balanced on conventionally wired XLRs (pin 1 screen, pin 2 hot, pin 3 cold and XLR shell is connected to chassis). The operating level is nominally +4dBu. Balanced use is recommended.

fig.3 XLR WIRING



• Ground Loops:

If ground loop problems are encountered, never disconnect the mains earth, but instead, try disconnecting the signal screen on one end of each of the cables connecting the outputs of the S3 to the patchbay. If such measures are necessary, balanced operation is recommended.

• Interference:

If the S3 is to be used where it may be exposed to high levels of disturbance such as found close to a TV or radio transmitter, we advise that it is operated in a balanced configuration. The screens of the signal cables should be connected to the chassis connection on the XLR connector as opposed to connecting to pin 1. The S3 conforms to the EMC standards.

POWER CONNECTION

The unit will have been supplied with a power cable suitable for domestic power outlets in your country. For your own safety it is important that you use this cable. The unit should **always** be connected to the mains supply earth using this cable, and no other.

If for some reason the unit is to be used at a mains input operating voltage which is different to that as supplied, the following procedure must be carried out.

- 1: Disconnect the unit from the mains.
- 2: Remove the two screws holding the voltage selection cover-plate.
- 3: Remove the cover plate and slide the switch fully to its opposite end.
- 4: Rotate the cover plate one half turn (180 degrees) and refit the two screws.
- 5: Replace with a correctly rated fuse for the selected operation voltage in the IEC socket:
230V-T500mA and 115V-T1Amp
- 6: Re-connect to mains power source.

**Never disconnect the earth
from the mains supply**

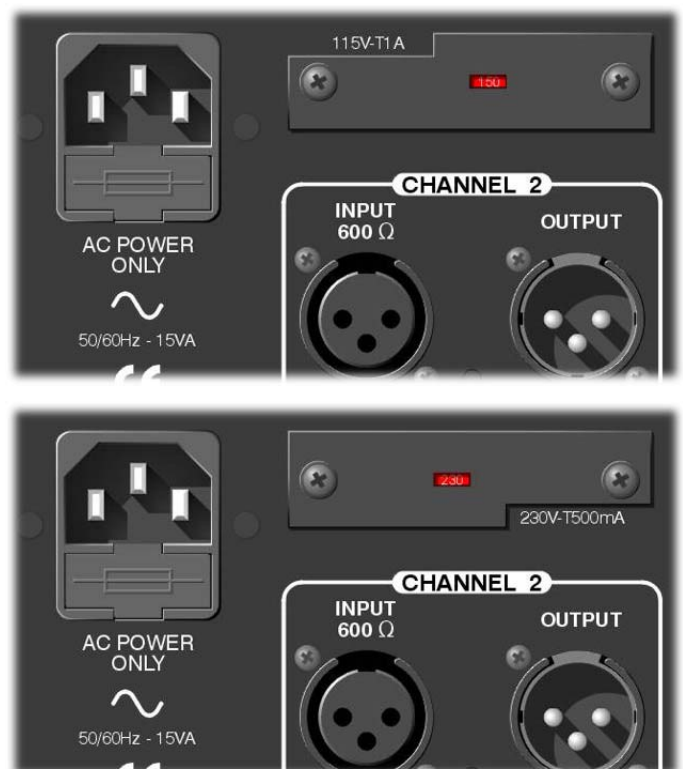
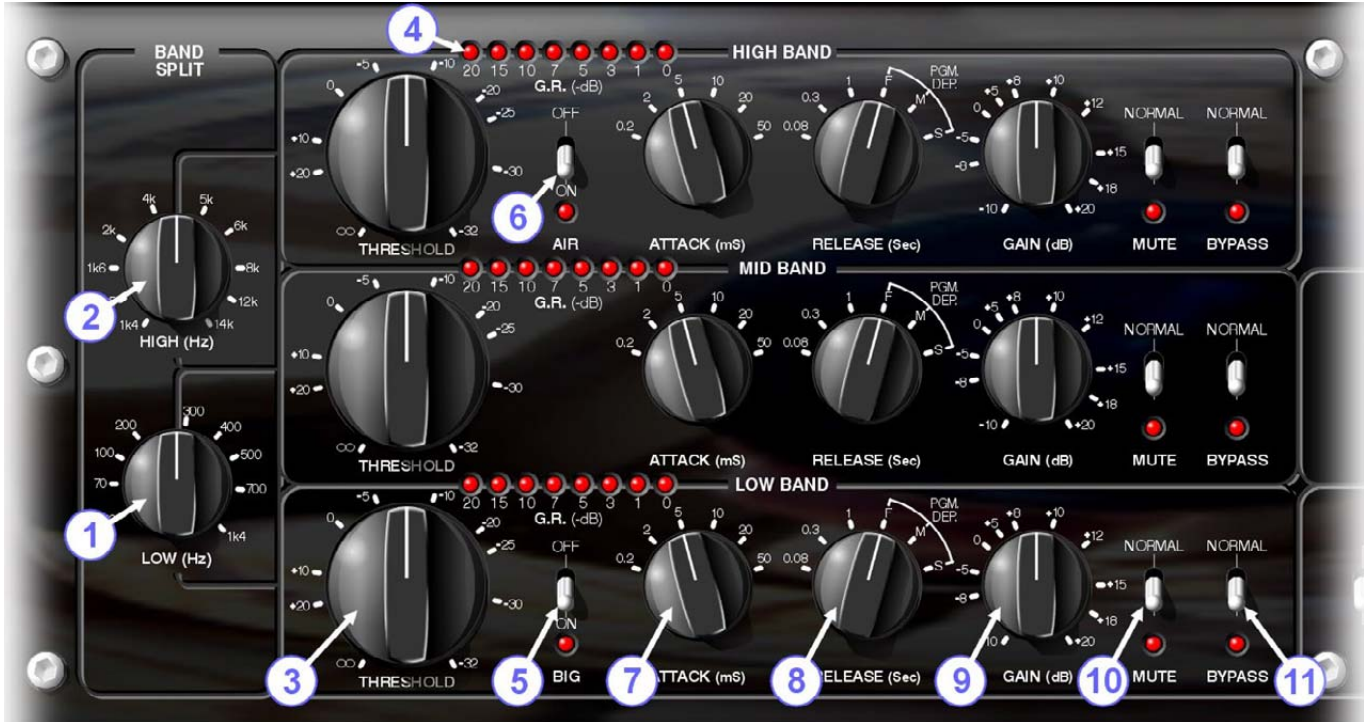

fig.4 Altering the Voltage

CONTROL DESCRIPTION



BAND SPLIT

The 6dB per octave crossover frequencies determine the points within the frequency spectrum one band stops to process audio, and another band takes over.

- 1 **Low Split Frequency:** 60Hz - 1.4kHz
Sets the frequency point at which the split between low and mid bands occurs.
- 2 **High Split Frequency:** 1.4kHz - 14kHz
Sets the frequency point at which the split between mid and high bands occurs.

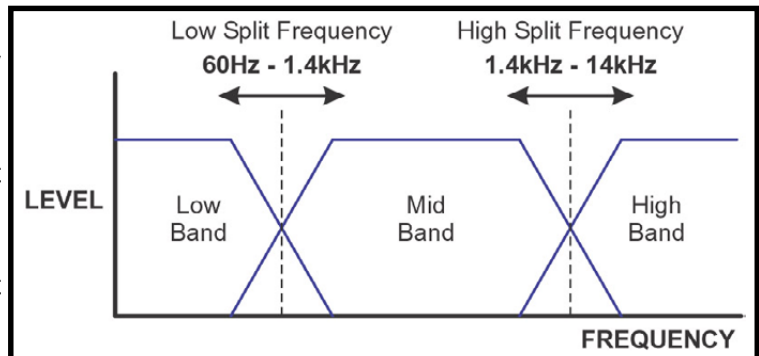

The following diagram provides a good, but general, idea of some useful frequencies:

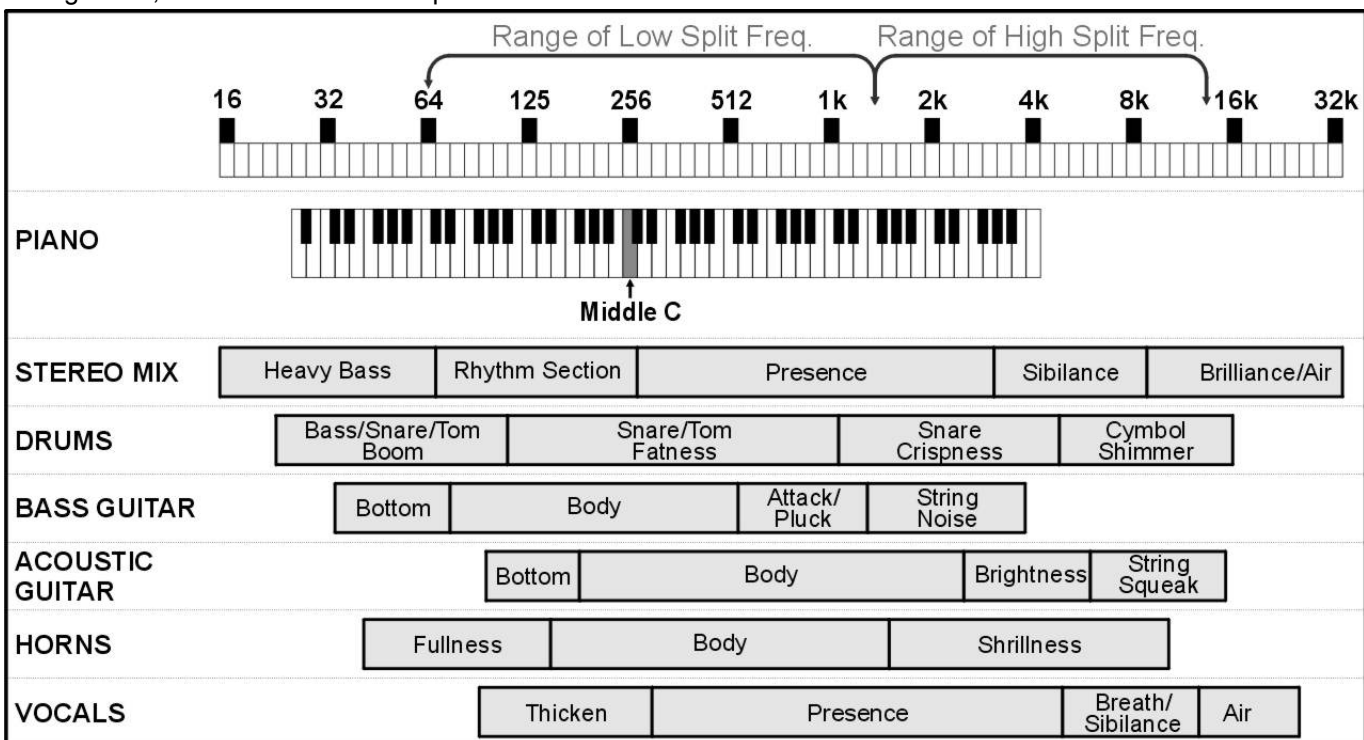

LOW BAND, MID BAND, HIGH BAND

3 Threshold: *infinity - -32dB* *all bands*
 Determines the level below which compression starts to take place. The S3 incorporates a Soft Knee, more compression is applied automatically as the input signal level increases, negating the need for a Ratio control.

4 Gain Reduction Meter: *all bands*
 Eight Leds at *0,-1,-3,-5,-7,-10,-15,-20dB*

5 Big: *Off - On* *low band only*
 Reduces the ducking effect caused by bass energy and effectively boosts the bass output.

6 Air: *Off - On* *high band only*
 Use to brighten and enhance the high band detail. Cymbals sound more vibrant without becoming splashy, vocals sound more open but without becoming sibilant.

7 Attack: *see Fig. 5* *all bands*
 Controls the speed that the compressor responds to signals that exceed the level set by threshold. Six switchable Attack settings. All times are nominal, the actual attack time is further modified by the release setting chosen.

8 Release: *see Fig. 6* *all bands*
 Sets the time taken for the signal to return to normal after the input level has fallen below threshold. The first three switch positions are fixed and provide progressively increasing release times, while positions F(ast), M(id) and S(low) cause the release times to vary in a manner which automatically adapts to the dynamics of the incoming signal.

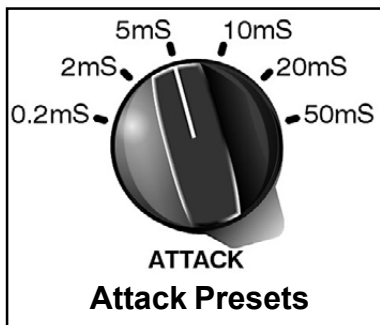
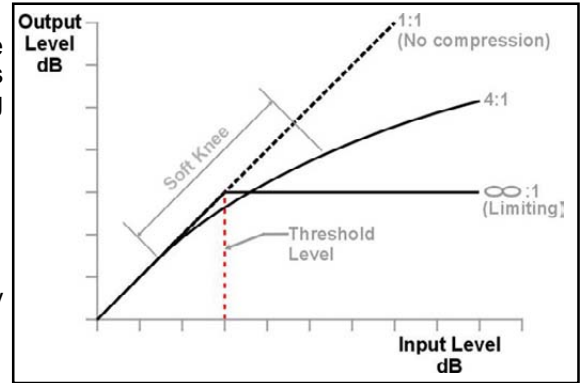

9 Gain: *-10 - +20dB* *all bands*
 During compression the signal is attenuated, gain may be required to produce the required output level. In addition, as the S3 is multi-band, the three gain controls are used to adjust the levels of each band to obtain a desirable overall signal, or to bring out the bass, treble etc.

10 Mute: *Off - On* *all bands*
 In the "MUTE" position the signal for that particular band is effectively turned off. Any combination of mute is available - to hear only the signal of the low band mute the mid and high bands etc.

11 Bypass: *Off - On* *all bands*
 In the "BYPASS" position the signal for the low, mid, or high band is allowed to pass through to the summing stage without being altered by the compressor stage (including gain). Using a combination of mute and bypass switches for the various bands allows the operator to hear and monitor only the frequencies that are required and so tune the low and high frequency settings.

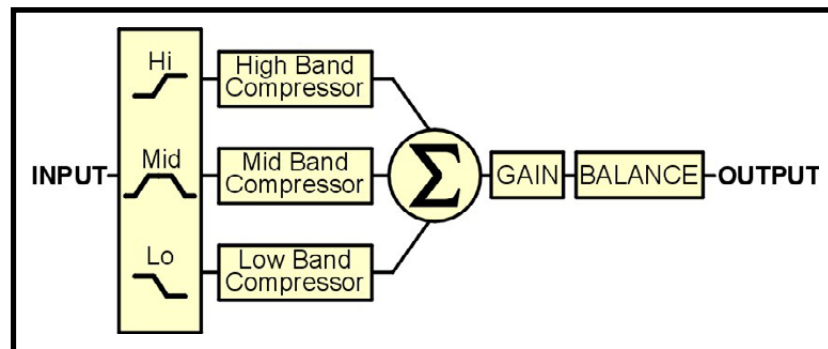

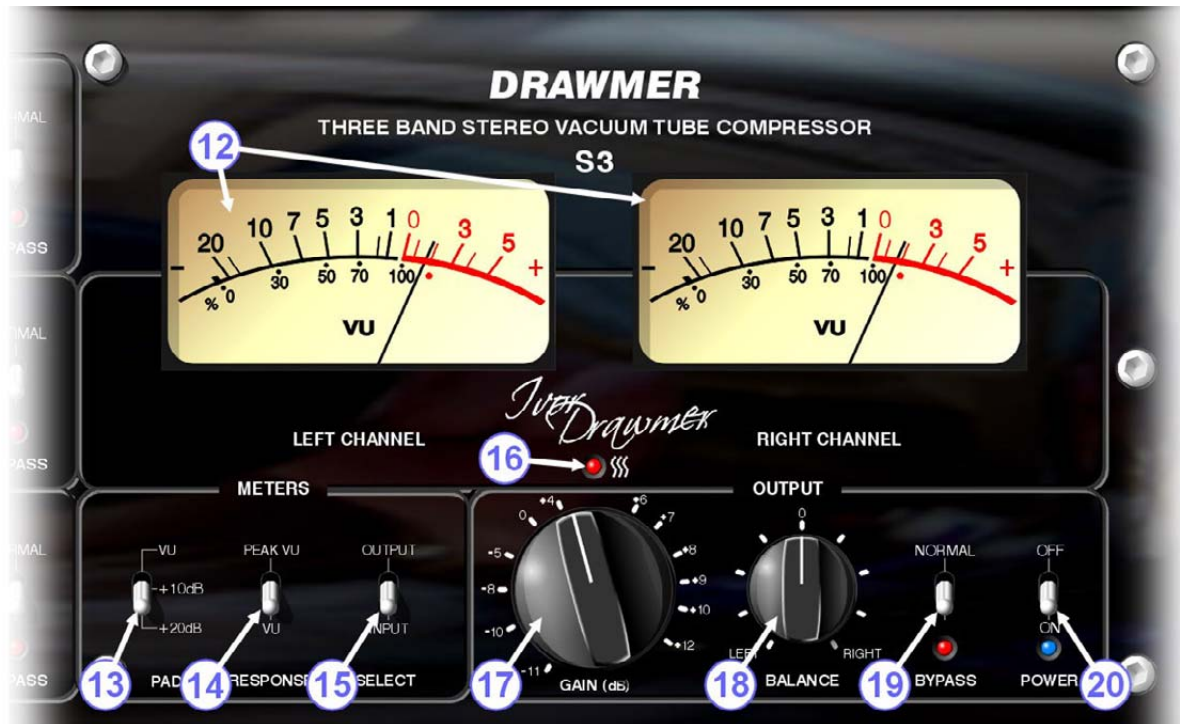

METERS

12 VU Meter:

Two moving coil VU meters monitor either the level of the input or output signal.

13 Pad:

Vu - +10dB - +20dB

A three-position switch adjusts the meters to show either normal output level, (and for those working at 'hot' output levels) VU +10dB or VU +20dB modes. i.e. with the switch at VU +10dB - when the VU meter reads 0dB the actual level is +10dB.

14 Response:

Peak VU - VU

On smooth, gentle pieces of music the "VU" (average level) setting would be sufficient, however, on fast dynamic signals the "Peak VU" setting provides more accurate readings.

15 Select:

Output - Input

Set to "Input" and adjust the level of the incoming signal: an optimal level of 0dB provides optimum headroom and signal-to-noise ratio. If the input level is too low little compression will occur (and, raising the overall output level of the signal will amplify the noise floor).

The Output setting shows the signal level after the signal has been summed and the "Gain" (17) and "Balance" (18) have been applied.

OUTPUT

16 Temperature Led \lll

The S3 is at optimum temperature when the front panel LED indicator is lit, i.e. after the soft start and when the valves have reached optimum temperature - this may take a few seconds.

17 Gain:

-11 - +12dB

The S3 provides a single control to modify the stereo output level after summing, without having to adjust the three band gain controls (and thus altering the mix). Adjust so that the output signal approaches the desired level only on signal peaks.

18 Balance:

Left - 0 - Right

Modifies left/right balance within the stereo mix.

19 Bypass:

Off - On

A fully balanced hard-wire unit bypass connects the input directly to the output.

Note: in bypass the VU meters display the levels as though the unit is still compressing until the Meter Select switch is set to "Input". This has been implemented to provide the user with optimum control of the meters.

20 Power:

Off - On

QUICK SETUP PROCEDURE

Please note that the following procedure is only a guide. All audio is different, requiring numerous settings, however, this should give a good starting point:

- 1) Set the compressor settings to be the same on all bands - **Threshold** at "infinite", **Gain** at 0dB, the **Attack** in a mid position (2 or 3) and **Release** set to F(ast). The overall **Gain** control should be set to 0dB, and the **Balance** at 0.

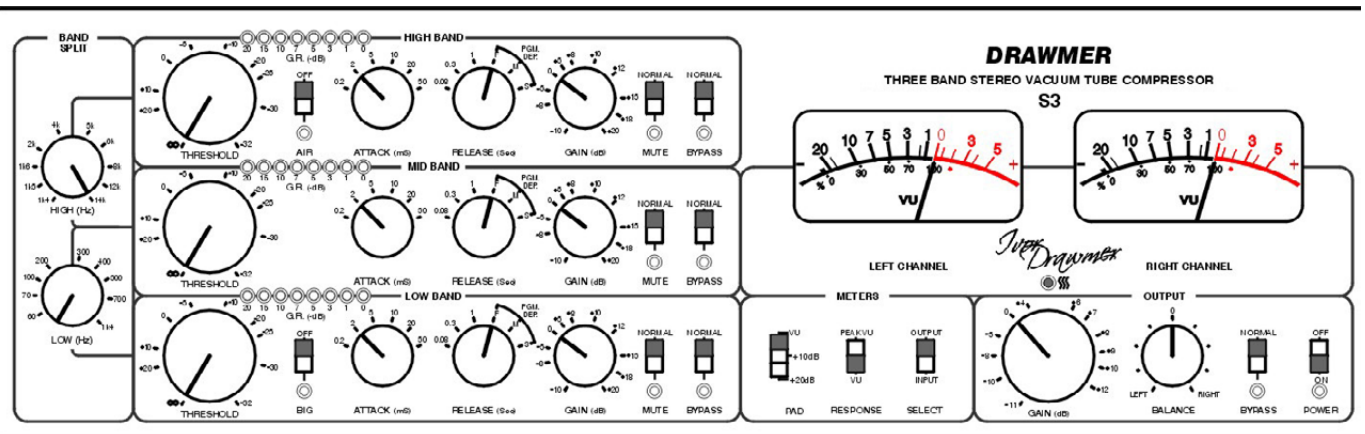

- 2) Set the **Meter Select** switch to **Input** and adjust the incoming signal so that the meters read 0dB. Set the switch to **output**.
- 3) With the **Low Frequency Split** set fully counter-clockwise, and the **High Frequency Split** set fully clockwise, listen to the audio and bring in the two knobs to the positions that you think the cross-over points should be set - generally to separate the main bass and treble sounds from the mid-range. Using a combination of **Mute** and **Bypass** switches for the various bands allows the operator to monitor only the frequencies that are required and so tune the low, mid and high frequencies.
- 4) Keeping an eye on the **Gain Reduction Meters** alter the **Threshold** level control for each band until the desired compression level is achieved - a G.R. level up to -10dB is acceptable.
- 5) Adjust the **Gain** control of each band until 0dB is reached on the **Output VU meter**. To see only the band that is being adjusted on the VU meter **Mute** the other two bands.
- 6) Set the **Attack** and **Release** settings of each band to suit the audio being compressed.
- 7) The **Threshold** and **Gain** of each band can be modified to achieve the desired compression, levels and tonal balance to the overall signal.
- 8) At this point the **Bypass** switches can be toggled to listen to the affect that the S3 is having on the audio. Adjust to suit.
- 9) Once each band is setup correctly modify the overall **Output Gain** and **Balance** until the VU meters read 0dB (more if in +10dB VU or +20dB modes).

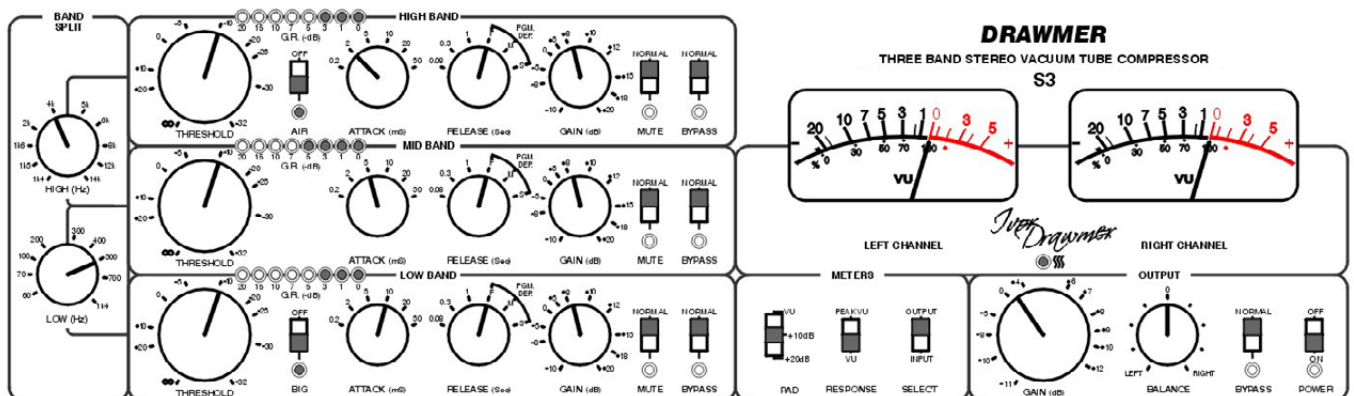

Above is an example setup that could be used for a General Pop Mix, though, of course, as all music is diverse and varied, will not be ideal elsewhere.

GENERAL INFORMATION

IF A FAULT DEVELOPS

For warranty service please call Drawmer Electronics Ltd. or their nearest authorised service facility, giving full details of the difficulty.

A list of all main dealers can be found on the Drawmer webpages.

On receipt of this information, service or shipping instructions will be forwarded to you.

No equipment should be returned under the warranty without prior consent from Drawmer or their authorised representative.

For service claims under the warranty agreement a service Returns Authorisation (RA) number will be issued. Write this RA number in large letters in a prominent position on the shipping box. Enclose your name, address, telephone number, copy of the original sales invoice and a detailed description of the problem.

Authorised returns should be prepaid and must be insured.

All Drawmer products are packaged in specially designed containers for protection. If the unit is to be returned, the original container must be used. If this container is not available, then the equipment should be packaged in substantial shock-proof material, capable of withstanding the handling for the transit.

CONTACTING DRAWMER

Drawmer Electronics Ltd., will be pleased to answer all application questions to enhance your usage of this equipment. Please address correspondence to:

Drawmer (Technical Help line)
Coleman Street
Parkgate
Rotherham
S62 6EL
UK

Alternatively contact us by E-mail on :

for sales enquiries: sales@drawmer.com
or for technical issues: tech@drawmer.com

Further information on all Drawmer dealers, Authorised service departments and other contact information can be obtained from our web pages on:

<http://www.drawmer.com>

S3 THREE-BAND STEREO VACUUM TUBE COMPRESSOR DATA SPECIFICATION

INPUT

Input Impedance 600 Ohms or greater
Maximum Input Level +30dBu

OUTPUT

Output Impedance 600 Ohms
Maximum Output Level +30dBu @ 10k Ohms Load
+26dBu @ 600 Ohms Load

FREQUENCY RESPONSE

<24Hz to 38kHz -1dB
<10Hz to 60kHz -3dB

CROSSTALK

< -80dB @ 10kHz
< -74dB @ 20kHz

NOISE AT UNITY GAIN

with flat EQ response switched in circuit

	Wideband	22Hz - 22kHz
AV	-79dB	-84dB
	-87dB	-94dB

% DISTORTION (THD & NOISE) @ 1kHz

0dB (ref +4) 0.03%
10dB (ref +4) 0.1%
20dB (ref +4) 0.4%

POWER REQUIREMENTS

230Volt or 115V at 50-60Hz, 60VA

FUSE RATING

T500mA for 230Volt, T1A for 115Volt
Conforming to IEC 127-2

FUSE TYPE

20mm x 5mm, Class 3 Timed-Blo, 250Volt working

CASE SIZE

482mm (W) x 132mm (H) x 315mm (D)

WEIGHT

9.7Kgs

BLOCK DIAGRAM

